

PERFORMANCE
MADE
SMARTER

Product manual

5714

Programmable LED indicator



TEMPERATURE | I.S. INTERFACES | COMMUNICATION INTERFACES | MULTIFUNCTIONAL | ISOLATION | DISPLAY

No. 5714V105-UK
From serial number: 191046001

PR
electronics

6 Product Pillars

to meet your every need

Individually outstanding, unrivalled in combination

With our innovative, patented technologies, we make signal conditioning smarter and simpler. Our portfolio is composed of six product areas, where we offer a wide range of analog and digital devices covering over a thousand applications in industrial and factory automation. All our products comply with or surpass the highest industry standards, ensuring reliability in even the harshest of environments and have a 5-year warranty for greater peace of mind.

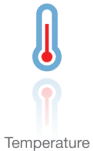

Our range of temperature transmitters and sensors provides the highest level of signal integrity from the measurement point to your control system. You can convert industrial process temperature signals to analog, bus or digital communications using a highly reliable point-to-point solution with a fast response time, automatic self-calibration, sensor error detection, low drift, and top EMC performance in any environment.



We deliver the safest signals by validating our products against the toughest safety standards. Through our commitment to innovation, we have made pioneering achievements in developing I.S. interfaces with SIL 2 Full Assessment that are both efficient and cost-effective. Our comprehensive range of analog and digital intrinsically safe isolation barriers offers multifunctional inputs and outputs, making PR an easy-to-implement site standard. Our backplanes further simplify large installations and provide seamless integration to standard DCS systems.



We provide inexpensive, easy-to-use, future-ready communication interfaces that can access your PR installed base of products. All the interfaces are detachable, have a built-in display for readout of process values and diagnostics, and can be configured via push-buttons. Product specific functionality includes communication via Modbus and Bluetooth and remote access using our PR Process Supervisor (PPS) application, available for iOS and Android.



Our unique range of single devices covering multiple applications is easily deployable as your site standard. Having one variant that applies to a broad range of applications can reduce your installation time and training, and greatly simplify spare parts management at your facilities. Our devices are designed for long-term signal accuracy, low power consumption, immunity to electrical noise and simple programming.



Our compact, fast, high-quality 6 mm isolators are based on microprocessor technology to provide exceptional performance and EMC-immunity for dedicated applications at a very low total cost of ownership. They can be stacked both vertically and horizontally with no air gap separation between units required.



Our display range is characterized by its flexibility and stability. The devices meet nearly every demand for display readout of process signals and have universal input and power supply capabilities. They provide a real-time measurement of your process value no matter the industry and are engineered to provide a user-friendly and reliable relay of information, even in demanding environments.

Programmable LED indicator 5714

Table of contents

Warning	4
Symbol identification	4
Safety instructions	5
Front and back layout	6
Application	7
Technical characteristics	7
Mounting	7
Applications	8
Order	9
Electrical specifications	9
Sensor error detection / sensor error detection outside range	12
Connections	14
Block diagram	15
Routing diagram	17
Scrolling help text	18
Configuration / operating the function keys	20
Graphic depiction of the relay function setpoint	21
Installation instructions	22
Document history	23

Warning



GENERAL

This device is designed for connection to hazardous electric voltages. Ignoring this warning can result in severe personal injury or mechanical damage. To avoid the risk of electric shock and fire, the safety instructions of this manual must be observed and the guidelines followed. The specifications must not be exceeded, and the device must only be applied as described in the following. Prior to the commissioning of the device, this manual must be examined carefully. Only qualified personnel (technicians) should install this device. If the equipment is used in a manner not specified by the manufacturer, the protection provided by the equipment may be impaired.

Warning



**HAZARDOUS
VOLTAGE**

Until the device is fixed, do not connect hazardous voltages to the device. The following operations should only be carried out on a disconnected device and under ESD-safe conditions:

 Troubleshooting the device.

Repair of the device must be done by PR electronics A/S only.



Symbol identification



Triangle with an exclamation mark: Read the manual before installation and commissioning of the device in order to avoid incidents that could lead to personal injury or mechanical damage. Warning / demand. Potentially lethal situations.



The CE mark proves the compliance of the device with the essential requirements of the EU directives.



The **UKCA mark** proves the compliance of the device with the essential requirements of the UK regulations.



The double insulation symbol shows that the device is protected by double or reinforced insulation.

Safety instructions

Definitions

Hazardous voltages have been defined as the ranges: 75 to 1500 Volt DC, and 50 to 1000 Volt AC.

Technicians are qualified persons educated or trained to mount, operate, and also trouble-shoot technically correct and in accordance with safety regulations.

Operators, being familiar with the contents of this manual, adjust and operate the knobs or potentiometers during normal operation.

Receipt and unpacking

Unpack the device without damaging it and check whether the device type corresponds to the one ordered. The packing should always follow the device until this has been permanently mounted.

Environment

Avoid direct sun light, dust, high temperatures, mechanical vibrations and shock, and rain and heavy moisture. If necessary, heating in excess of the stated limits for ambient temperatures should be avoided by way of ventilation.

The device must be installed in pollution degree 2 or better.

The device is designed to be safe at least under an altitude up to 2 000 m.

The device is designed for indoor use.

Mounting

Only technicians, who are familiar with the technical terms, warnings, and instructions in the manual and who are able to follow these, should connect the device. Should there be any doubt as to the correct handling of the device, please contact your local distributor or, alternatively,

PR electronics A/S
www.prelectronics.com

Mounting and connection of the device should comply with national legislation for mounting of electric materials, i.e. wire cross section, protective fuse, and location.

Stranded wire should be installed with an insulation stripping length of 5 mm or via a suitable insulated terminal such as a bootlace ferrule.

Descriptions of input / output and supply connections are shown in the block diagram and side label.

The following apply to fixed hazardous voltages-connected devices:

The max. size of the protective fuse is 10 A and, together with a power switch, it should be easily accessible and close to the device. The power switch should be marked with a label telling it will switch off the voltage to the device.

Year of manufacture can be taken from the first two digits in the serial number.

Calibration and adjustment

During calibration and adjustment, the measuring and connection of external voltages must be carried out according to the specifications of this manual. The technician must use tools and instruments that are safe to use.

Normal operation

Operators are only allowed to adjust and operate devices that are safely fixed in panels, etc., thus avoiding the danger of personal injury and damage. This means there is no electrical shock hazard, and the device is easily accessible.

Cleaning

When disconnected, the device may be cleaned with a cloth moistened with distilled water.

Liability

To the extent the instructions in this manual are not strictly observed, the customer cannot advance a demand against PR electronics A/S that would otherwise exist according to the concluded sales agreement.

Front and back layout



Picture 1: Front of 5714.

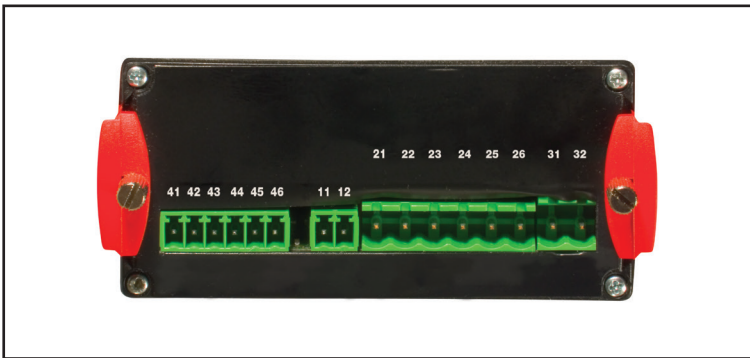

Picture 2: Back of 5714.

Programmable LED indicator 5714

- 4-digit 14-segment LED indicator
- Input for mA, V, potentiometer, Ohm, RTD and TC
- 2 relays and analog output
- Universal voltage supply
- Front key programmable

Application

- Display for digital readout of current, voltage, resistance, temperature or potentiometer signals.
- Process control with 2 pairs of potential-free relays and / or analogue output.
- For local readout in extremely wet atmospheres with a specially designed splash-proof cover.

Technical characteristics

- 4-digit LED indicator with 13.8 mm 14-segment characters. Max. display readout -1999...9999 with programmable decimal point, relay ON / OFF indication.
- 2.3 kVAC galvanic isolation between input, output and supply.
- All operational parameters can be adjusted to any application by use of the front keys.
- 5714 is available fully-configured acc. to specifications ready for process control and visualisation.
- Help texts in eight languages can be selected via a menu item.
- In versions with relay outputs the user can minimise the installation test time by activating / deactivating each relay independently of the input signal.

Mounting

- To be mounted in front panel. The included rubber packing must be mounted between the panel cutout hole and the display front to obtain a protection degree of IP65 (type 4X). For extra protection in extreme environments, 5714 can be delivered with a specially designed splash-proof cover as accessory.

Applications

Input signals:

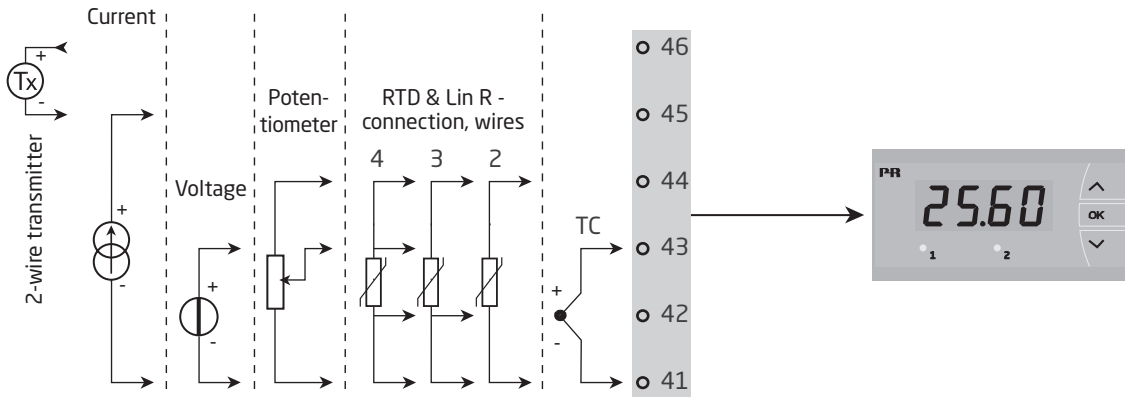

Output signals:

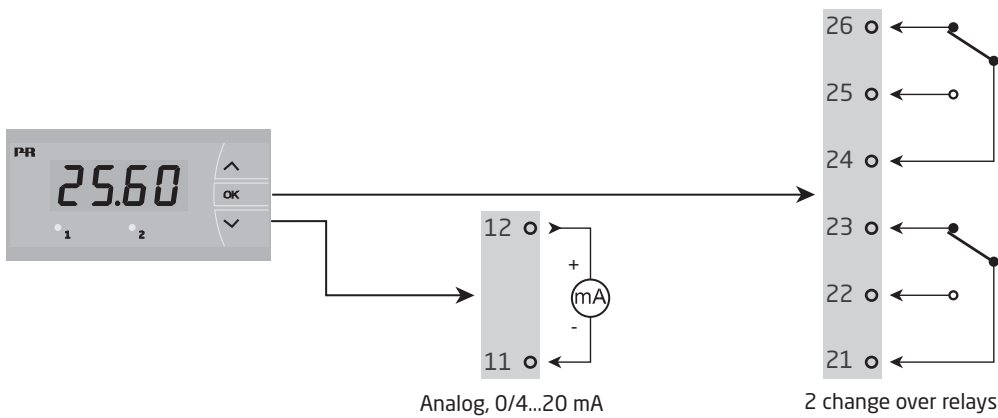

Supply:

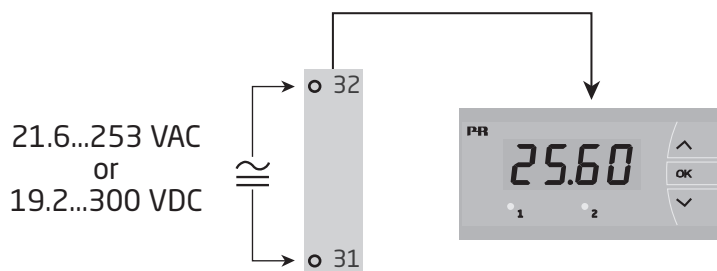

Order

Type	Version
5714	Standard : A
	2 relays : B
	Analog output : C
	Analog output and 2 relays : D

NB! Please order the splash-proof cover separately. Order No. 8335.

Electrical specifications

Environmental conditions:

Ambient operating temperature range	-20°C to +60°C
Calibration temperature.	20...28°C
Humidity.	< 95% RH (non-cond.)
Protection degree (mounted in panel)	IP65 / Type 4X

Mechanical specifications:

Dimensions (HxWxD)	48 x 96 x 120 mm
Cutout dimensions.	44.5 x 91.5 mm
Weight	230 g
Wire size, pin 41...46 max.	0.05...1.31 mm ² AWG 30...16 stranded wire
Wire size, others max.	0.05...3.31 mm ² / AWG 30...12 stranded wire
Vibration.	IEC 60068-2-6
2...13.2 Hz	±1 mm
13.2...100 Hz.	±0.7 g

Common specifications:

Supply voltage, universal.	21.6...253 VAC, 50...60 Hz or 19.2...300 VDC
------------------------------------	---

Type	Internal power dissipation	Max. required power
5714A	2.2 W	2.5 W
5714B/C	2.7 W	3.0 W
5714D	3.2 W	3.5 W

Isolation voltage, test / operation.	2.3 kVAC / 250 VAC
Signal- / noise ratio	Min. 60 dB (0...100 kHz)
Response time (0...90 %, 100...10 %), programmable:	
Temperature input.	1...60 s
Current / voltage input	0.4...60

Accuracy, the greater of the general and basic values:

General values		
Input type	Absolute accuracy	Temperature coefficient
All	≤ ±0.1% of reading	≤ ±0.01% of reading / °C

Basic values		
Input type	Basic accuracy	Temperature coefficient
mA	$\leq \pm 4 \mu\text{A}$	$\leq \pm 0.4 \mu\text{A} / ^\circ\text{C}$
Volt	$\leq \pm 20 \mu\text{V}$	$\leq \pm 2 \mu\text{V} / ^\circ\text{C}$
Pt100	$\leq \pm 0.2^\circ\text{C}$	$\leq \pm 0.01^\circ\text{C} / ^\circ\text{C}$
Linear resistance	$\leq \pm 0.1^\circ\Omega$	$\leq \pm 0.01 \Omega / ^\circ\text{C}$
Potentiometer	$\leq \pm 0.1^\circ\Omega$	$\leq \pm 0.01 \Omega / ^\circ\text{C}$
TC type: E, J, K, L, N, T, U	$\leq \pm 1^\circ\text{C}$	$\leq \pm 0.05^\circ\text{C} / ^\circ\text{C}$
TC type: R, S, W3, W5, LR	$\leq \pm 2^\circ\text{C}$	$\leq \pm 0.2^\circ\text{C} / ^\circ\text{C}$
TC type: B 85...200°C	$\leq \pm 4^\circ\text{C}$	$\leq \pm 0.4^\circ\text{C} / ^\circ\text{C}$
TC type: B 200...1820°C	$\leq \pm 2^\circ\text{C}$	$\leq \pm 0.2^\circ\text{C} / ^\circ\text{C}$

EMC - immunity influence. $< \pm 0.5\%$ of readout

Auxiliary supply:

2 wire supply, pin 46...45. $> 15 \text{ VDC} @ 0...20 \text{ mA}$

TC input

Type	Min. value	Max. value	Standard
B	0°C	+1820°C	IEC 60584-1
E	-100°C	+1000°C	IEC 60584-1
J	-100°C	+1200°C	IEC 60584-1
K	-180°C	+1372°C	IEC 60584-1
L	-200°C	+900°C	DIN 43710
N	-180°C	+1300°C	IEC 60584-1
R	-50°C	+1760°C	IEC 60584-1
S	-50°C	+1760°C	IEC 60584-1
T	-200°C	+400°C	IEC 60584-1
U	-200°C	+600°C	DIN 43710
W3	0°C	+2300°C	ASTM E988-90
W5	0°C	+2300°C	ASTM E988-90
LR	-200°C	+800°C	GOST 3044-84

Cold junction compensation (CJC) via internal sensor $\pm(2.0^\circ\text{C} + 0.4^\circ\text{C} * \Delta t)$

$\Delta t = \text{internal temperature} - \text{ambient temperature}$

Sensor error detection, all TC types. Yes

Sensor error current:

when detecting Nom. 2 μA

else. 0 μA

RTD, linear resistance and potentiometer input

Input type	Min. value	Max. value	Standard
Pt10...Pt1000	-200°C	+850°C	IEC 60751
Ni50...Ni1000	-60°C	+250°C	DIN 43760
Cu10...Cu100	-200°C	+260°C	$\alpha = 0.00427$
Lin. R	0 Ω	10000 Ω	-
Potentiometer	10 Ω	100 k Ω	-

Input for RTD types:

Pt10, Pt20, Pt50, Pt100, Pt200, PT250, Pt300, Pt400, Pt500, Pt1000

Ni50, Ni100, Ni120, Ni1000, Cu10, Cu20, Cu50, Cu100

Cable resistance pr. wire, RTD (max.) 50 Ω

Sensor current, RTD Nom. 0.2 mA

Effect of sensor cable resistance (3- / 4-wire), RTD < 0.002 Ω / Ω

Sensor error detection, RTD Yes

Short circuit detection, RTD < 15 Ω

Current input

Measurement range 0...23 mA

Programmable measurement ranges 0...20 and 4...20 mA

Input resistance Nom. 20 Ω + PTC 25 Ω

Sensor error detection:

loop break 4...20 mA Yes

Voltage input

Measurement range 0...12 VDC

Programmable measurement ranges 0...1 / 0.2...1 / 0...10 / 2...10 VDC

Input resistance Nom. 10 M Ω

Outputs

Display

Display readout -1999...9999 (4 digits)

Decimal point Programmable

Digit height 13.8 mm

Display updating 2.2 times / s

Input outside input range is indicated by Explanatory text

Current output

Signal range (span) 0...23 mA

Programmable signal ranges 0...20 / 4...20 / 20...0 / 20...4 mA

Load (max.) \leq 800 Ω

Load stability \leq 0.01% of span / 100 Ω

Sensor error detection 0 / 3.5 / 23 mA / none

NAMUR NE 43 up / downscale 23 mA / 3.5 mA

Output limitation:

on 4...20 and 20...4 mA signals 3,8...20.5 mA

on 0...20 and 20...0 mA signals 0...20.5 mA

Current limit. \leq 28 mA

Relay outputs

Relay function	Setpoint
Hysteresis.	0...100%
On and Off delay	0...3600 s
Sensor error detection	Make / Break / Hold
Max. voltage	250 VAC / VDC
Max. AC current.	2 A
Max. AC power	500 VA
Max. DC current, resistive load:	
@ $U_{\text{relay}} \leq 30$ VDC	2 ADC
@ $U_{\text{relay}} > 30$ VDC.	$[1380 \times U_{\text{relay}}^{-2} \times 1.0085^{U_{\text{relay}}}]$ ADC

Graphic depiction of $[1380 \times U_{\text{relay}}^{-2} \times 1.0085^{U_{\text{relay}}}]$:

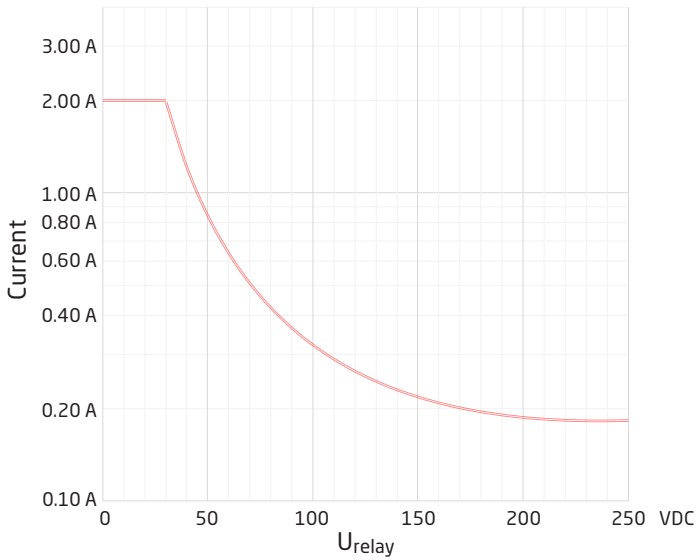

Observed authority requirements

EMC.	2014/30/EU & UK SI 2016/1091
LVD.	2014/35/EU & UK SI 2016/1101
RoHS.	2011/65/EU & UK SI 2012/3032
EAC.	TR-CU 020/2011

Approvals

EU RO Mutual Recognition Type Approval	MRA000000Z
c UL us, UL 508.	E248256

Sensor error detection / sensor error detection outside range

Sensor error check in 5714 variants		
Variant	Configuration	Sensor error detection
5714A	Always:	ON
5714B	ERR1=NONE, ERR2=NONE:	OFF
	else:	ON
5714C	O.ERR=NONE:	OFF
	else:	ON
5714D	ERR1=NONE, ERR2=NONE, O.ERR=NONE:	OFF
	else:	ON

Outside range readout (IN.LO, IN.HI): If the valid range of the A/D converter or the polynomial is exceeded			
Input	Range	Readout	Limit
VOLT	0...1 V / 0.2...1 V	IN.LO	< -25 mV
		IN.HI	> 1.2 V
	0...10 V / 2...10 V	IN.LO	< -25 mV
		IN.HI	> 12 V
CURR	0...20 mA / 4...20 mA	IN.LO	< -1.05 mA
		IN.HI	> 25.05 mA
POTM	-	IN.LO	< -0.5%
		IN.HI	> 100.5%
TEMP	TC / RTD	IN.LO	< temperature range -2°C
		IN.HI	> temperature range +2°C
LIN. R	0...800 ohm	IN.LO	< 0 ohm
		IN.HI	> 1 kohm
	0...10 kohm	IN.LO	< 0 ohm
		IN.HI	> 15 kohm

Sensor error detection (SE.BR, SE.SH)			
Input	Range	Readout	Limit
CURR	Loop break (4...20 mA)	SE.BR	<= 3.6 mA; > = 21 mA
TEMP	TC	SE.BR	> ca. 750 kohm / (1.25 V)
	RTD, 2-, 3- & 4-wire No SE.SH for Cuxx, Pt10, Pt20 & Pt50-	SE.BR	> 12 kohm
		SE.SH	< 15 ohm
LIN. R	0...800 ohm	SE.BR	> 875 ohm
	0...10 kohm	SE.BR	> 12 kohm

Display readout below min. / above max. (-1.9.9.9, 9.9.9.9)			
Input	Range	Readout	Limit
CURR VOLT	All	-1.9.9.9	Display readout <-1999
		9.9.9.9	Display readout >9999
LIN. R	All	-1.9.9.9	Display readout <-1999
		9.9.9.9	Display readout >9999
POTM	-	-1.9.9.9	Display readout <-1999
		9.9.9.9	Display readout >9999

Readout at hardware error		
Error search	Readout	Cause
Test of internal communication μ C / ADC	HW.ER	Permanent error in ADC
Test of internal CJC sensor	CJ.ER	CJC sensor defect
Check-sum test of the configuration in RAM	RA.ER	Error in RAM
Check-sum test of the configuration in EEPROM	EE.ER	Error in EEPROM

! Error indications in the display blink once a second. The help text explains the error.

Connections

Inputs:

RTD & Lin R, 2-wire

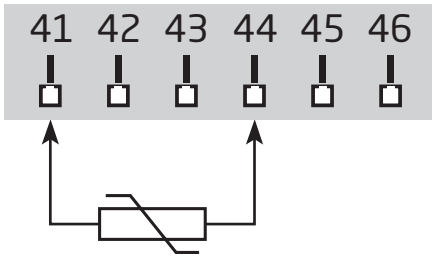

RTD & Lin R, 3-wire

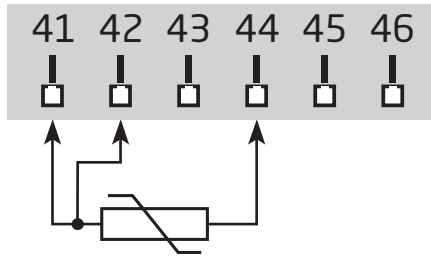

RTD & Lin R, 4-wire

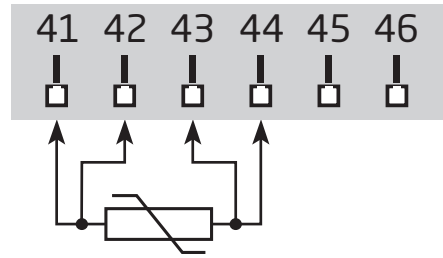

TC

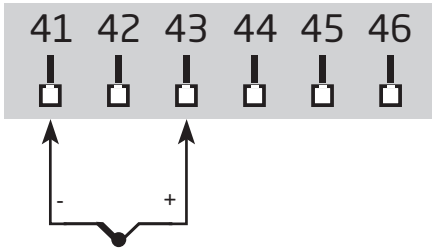

2-wire transmitter

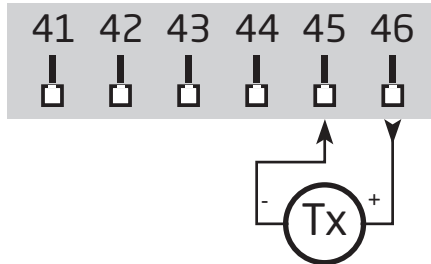

Current

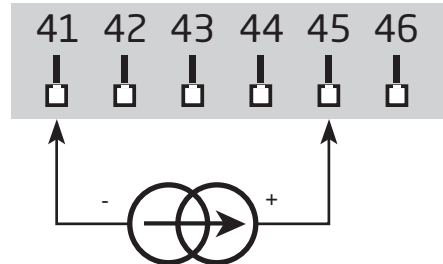

Voltage

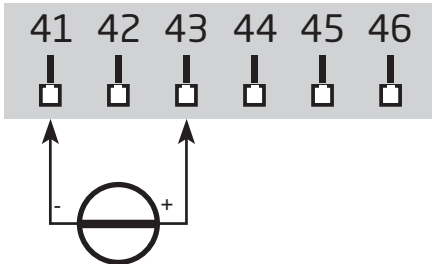

Potentiometer

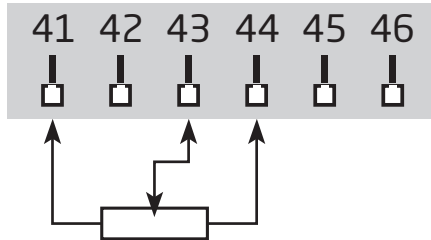

Output:

Supply:

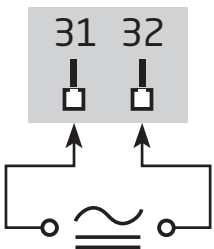

Current

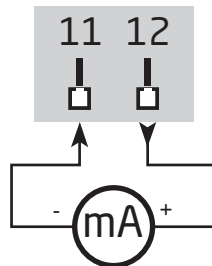

Relays

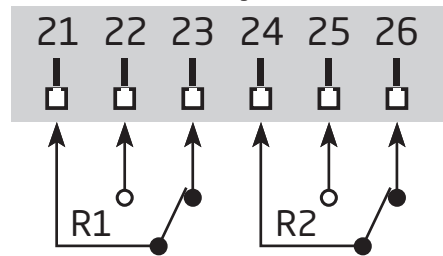

Block diagram

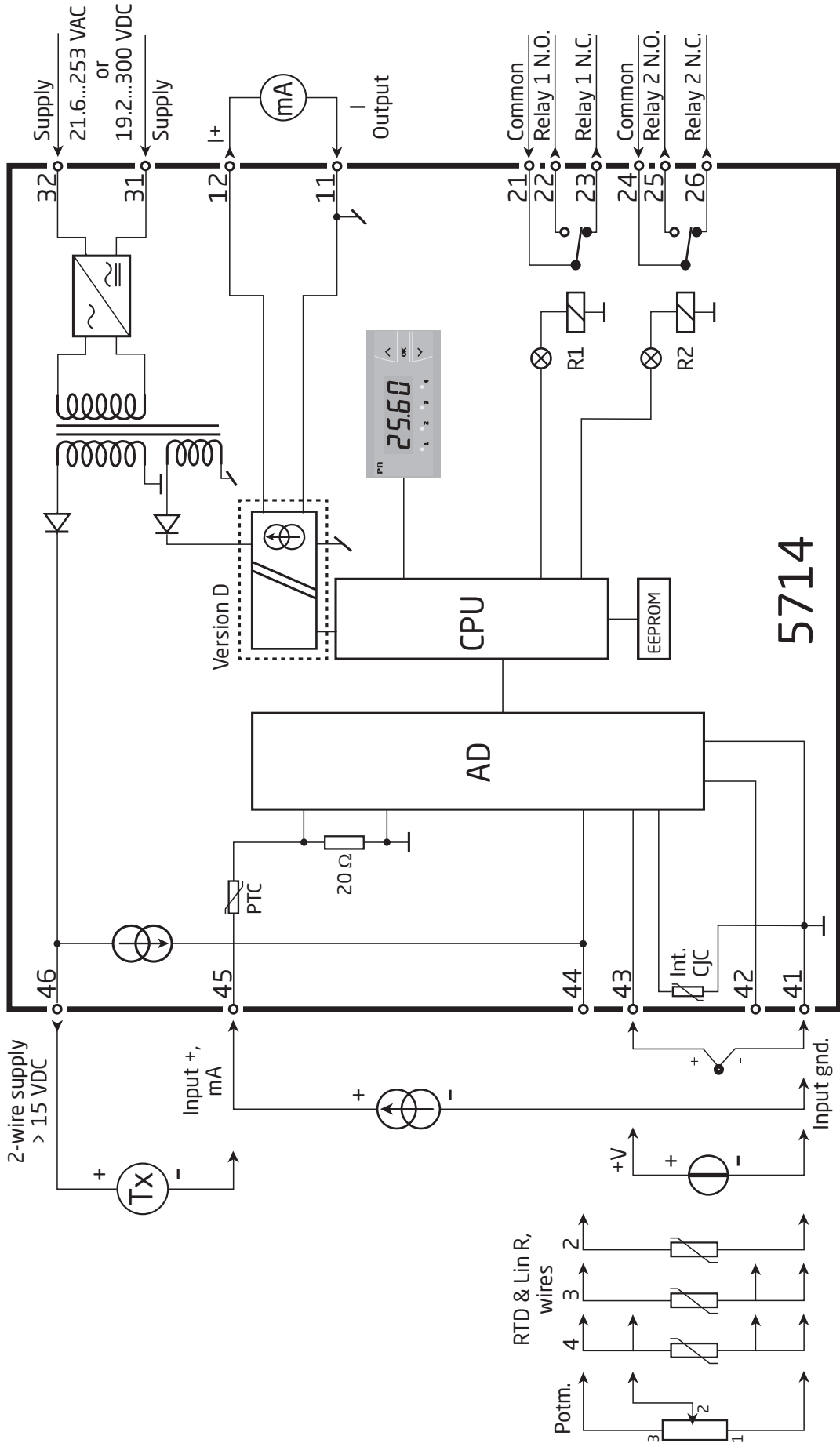

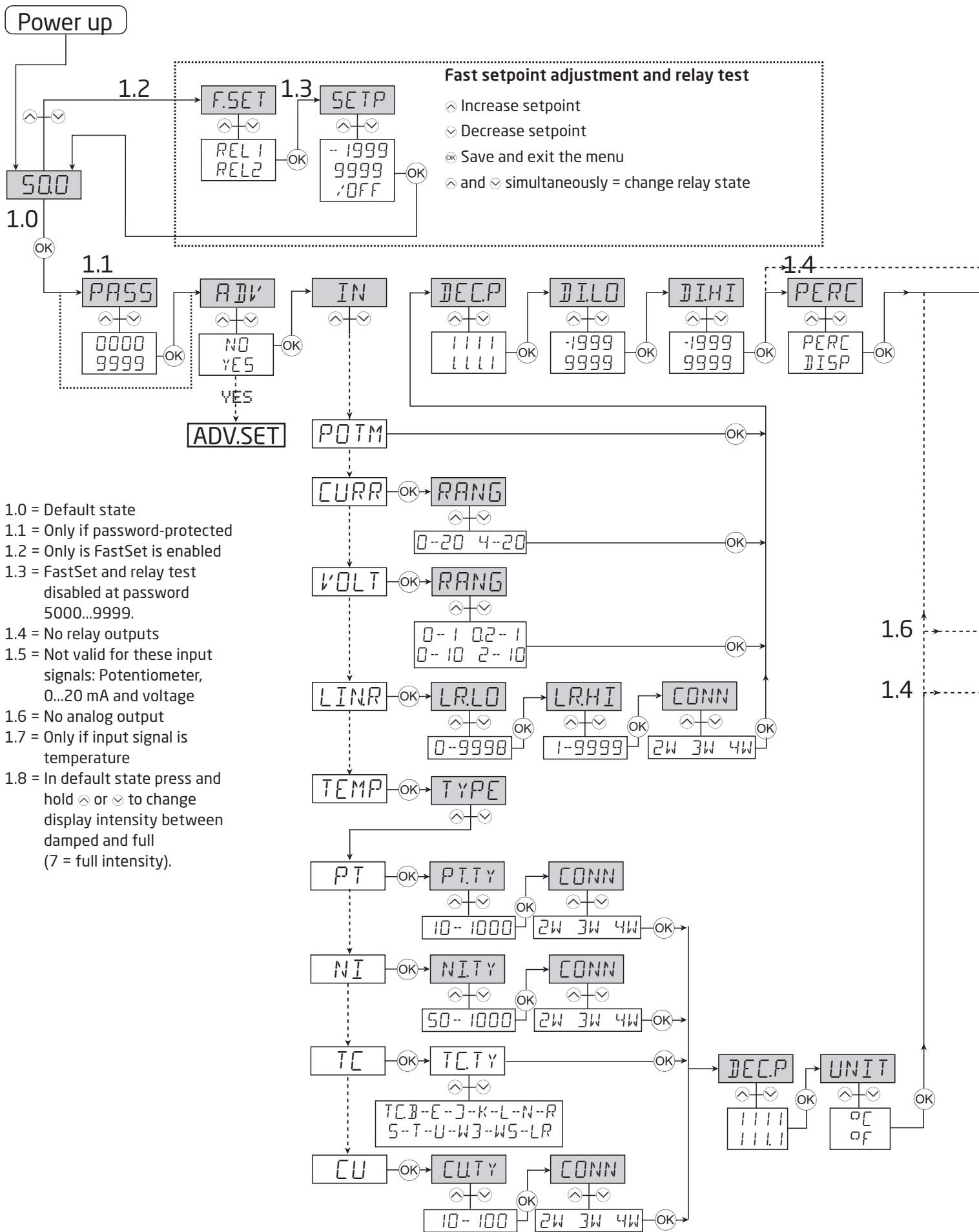

Routing diagram

If no keys are activated for 2 minutes the display returns to default state 1.0 without saving configuration changes.

- ⊕ Increase value / choose next parameter.
- ⊖ Decrease value / choose previous parameter.
- ⊗ Accept the chosen parameter and go to the next menu.
- Hold ⊗ Back to previous menu / return to menu 1.0 without saving.

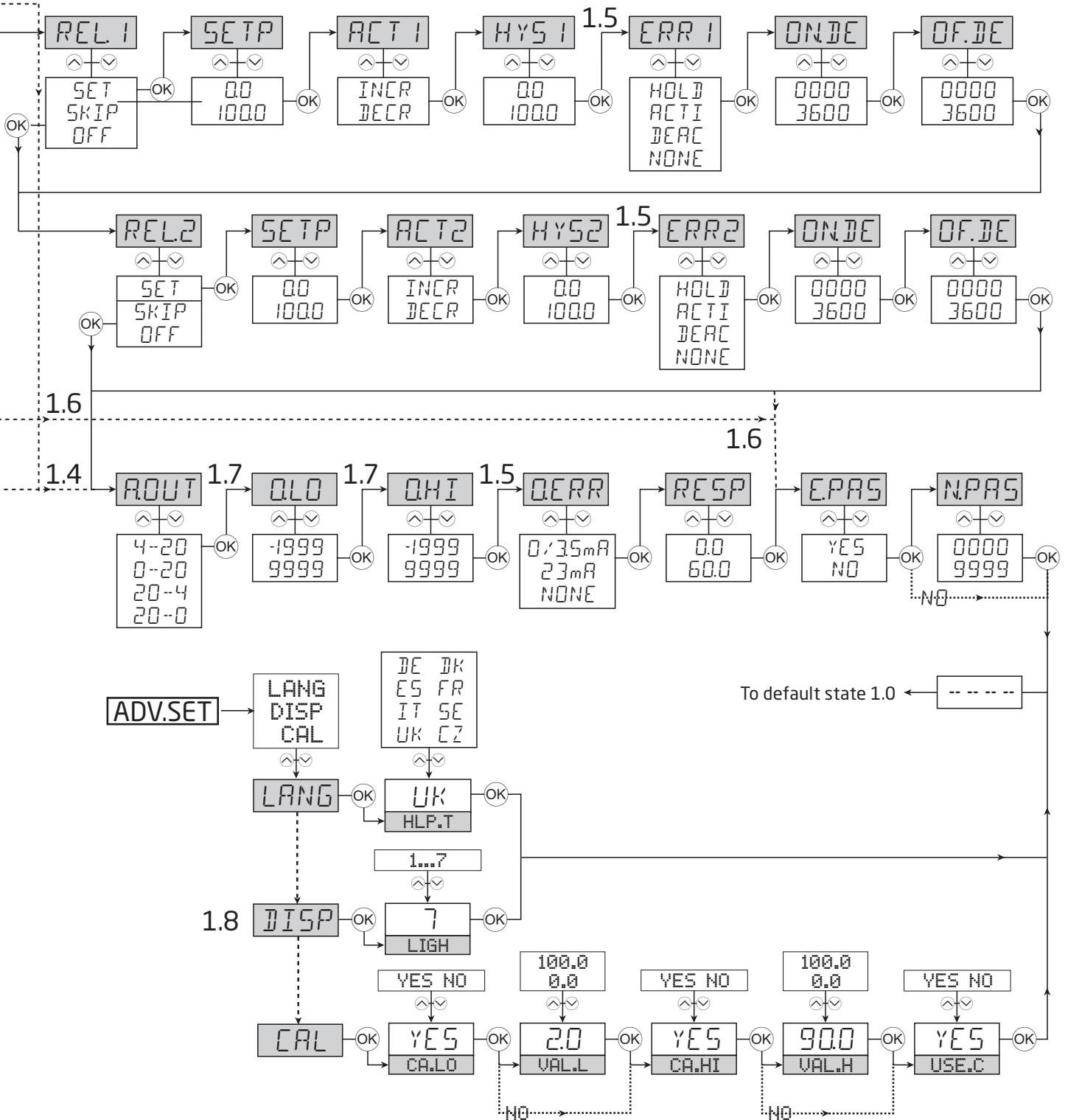

Scrolling help text

Display in default state xxxx, hardware error:

SE.BR --> SENSOR WIRE BREAKAGE
SE.SH --> SENSOR SHORT CIRCUIT
IN.HI --> INPUT OVERRANGE
IN.LO --> INPUT UNDERRANGE
9.9.9.9 --> DISPLAY OVERRANGE
-1.9.9.9 --> DISPLAY UNDERRANGE
HW.ER --> HARDWARE ERROR
EE.ER --> EEPROM ERROR - CHECK CONFIGURATION
RA.ER --> RAM MEMORY ERROR
CJ.ER --> CJC SENSOR ERROR

Fastset (Enabled):

F.SET
REL1 --> FAST SET MENU -
REL2 --> SELECT RELAY

SETP
 xxxx --> RELAY SETPOINT - PRESS OK TO SAVE

Fastset (Disabled):

SETP
 xxxx --> RELAY SETPOINT - READ ONLY

Configuration menus:

ADV
YES --> ENTER ADVANCED SETUP MENU?
NO

PASS
 xxxx --> SET CORRECT PASSWORD

IN
C.LIN* --> TEXT ENTERED BY USER IN PRESET
CURR --> CURRENT INPUT
VOLT --> VOLTAGE INPUT
POTM --> POTENTIOMETER INPUT
LIN.R --> LINEAR RESISTANCE INPUT
TEMP --> TEMPERATURE SENSOR INPUT

RANG When current selected:

0-20 --> INPUT RANGE IN mA
 4-20 --> INPUT RANGE IN mA

RANG When voltage selected:

0-10 --> INPUT RANGE IN VOLT
 2-10 --> INPUT RANGE IN VOLT
 0.0-1 --> INPUT RANGE IN VOLT
 0.2-1 --> INPUT RANGE IN VOLT

DEC.P

1111 --> DECIMAL POINT POSITION
 111.1 --> DECIMAL POINT POSITION
 11.11 --> DECIMAL POINT POSITION
 1.111 --> DECIMAL POINT POSITION

LR.LO

xxxx --> SET RESISTANCE VALUE LOW

LR.HI

xxxx --> SET RESISTANCE VALUE HIGH

DI.LO

xxxx --> DISPLAY READOUT LOW

DI.HI

xxxx --> DISPLAY READOUT HIGH

REL.U

PERC --> SET RELAY IN PERCENTAGE
 DISP --> SET RELAY IN DISPLAY UNITS

TYPE

CU --> SELECT CU SENSOR TYPE
 PT --> SELECT PT SENSOR TYPE
 NI --> SELECT NI SENSOR TYPE
 TC --> SELECT TC SENSOR TYPE

CU.TY

10 --> SELECT CU SENSOR TYPE
 20 --> SELECT CU SENSOR TYPE
 50 --> SELECT CU SENSOR TYPE
 100 --> SELECT CU SENSOR TYPE

PT.TY

10 --> SELECT PT SENSOR TYPE
 20 --> SELECT PT SENSOR TYPE
 50 --> SELECT PT SENSOR TYPE
 100 --> SELECT PT SENSOR TYPE
 200 --> SELECT PT SENSOR TYPE
 250 --> SELECT PT SENSOR TYPE
 300 --> SELECT PT SENSOR TYPE
 400 --> SELECT PT SENSOR TYPE
 500 --> SELECT PT SENSOR TYPE
 1000 --> SELECT PT SENSOR TYPE

NI.TY

50 --> SELECT NI SENSOR TYPE
 100 --> SELECT NI SENSOR TYPE
 120 --> SELECT NI SENSOR TYPE
 1000 --> SELECT NI SENSOR TYPE

CONN

When Cu, Pt and Ni sensor is selected
 2W --> SELECT 2-WIRE SENSOR CONNECTION
 3W --> SELECT 3-WIRE SENSOR CONNECTION
 4W --> SELECT 4-WIRE SENSOR CONNECTION

TC.TY

TC. B --> SELECT TC SENSOR TYPE
 TC. E --> SELECT TC SENSOR TYPE
 TC. J --> SELECT TC SENSOR TYPE
 TC. K --> SELECT TC SENSOR TYPE
 TC. L --> SELECT TC SENSOR TYPE
 TC. N --> SELECT TC SENSOR TYPE
 TC. R --> SELECT TC SENSOR TYPE
 TC. S --> SELECT TC SENSOR TYPE
 TC. T --> SELECT TC SENSOR TYPE
 TC. U --> SELECT TC SENSOR TYPE
 TC.W3 --> SELECT TC SENSOR TYPE
 TC.W5 --> SELECT TC SENSOR TYPE
 TC.LR --> SELECT TC SENSOR TYPE

DEC.P

When temperature selected
 1111 --> DECIMAL POINT POSITION
 111.1 --> DECIMAL POINT POSITION

UNIT

°C --> DISPLAY AND RELAY SETUP IN CELSIUS
 °F --> DISPLAY AND RELAY SETUP IN FAHRENHEIT

REL1
 SET --> ENTER RELAY 1 SETUP
 SKIP --> SKIP RELAY 1 SETUP
 OFF --> RELAY 1 DISABLED

SETP
 xxxx --> RELAY SETPOINT

ACT1
 INCR --> ACTIVATE AT INCREASING SIGNAL
 DECR --> ACTIVATE AT DECREASING SIGNAL

HYS1
 xxxx --> RELAY HYSTERESIS

ERR1
 HOLD --> HOLD RELAY AT ERROR
 ACTI --> ACTIVATE RELAY AT ERROR
 DEAC --> DEACTIVATE RELAY AT ERROR
 NONE --> UNDEFINED STATUS AT ERROR

ON.DE
 xxxx --> RELAY ON-DELAY IN SECONDS

OF.DE
 xxxx --> RELAY OFF-DELAY IN SECONDS

REL2
 SET --> ENTER RELAY 2 SETUP
 SKIP --> SKIP RELAY 2 SETUP
 OFF --> RELAY 2 DISABLED

SETP
 xxxx --> RELAY SETPOINT

ACT2
 INCR --> ACTIVATE AT INCREASING SIGNAL
 DECR --> ACTIVATE AT DECREASING SIGNAL

HYS2
 xxxx --> RELAY HYSTERESIS

ERR2
 HOLD --> HOLD RELAY AT ERROR
 ACTI --> ACTIVATE RELAY AT ERROR
 DEAC --> DEACTIVATE RELAY AT ERROR
 NONE --> UNDEFINED STATUS AT ERROR

ON.DE
 xxxx --> RELAY ON-DELAY IN SECONDS

OF.DE
 xxxx --> RELAY OFF-DELAY IN SECONDS

A.OUT
 0-20 --> OUTPUT RANGE IN mA
 4-20 --> OUTPUT RANGE IN mA
 20-0 --> OUTPUT RANGE IN mA
 20-4 --> OUTPUT RANGE IN mA

O.LO
 xxxx --> DISPLAY VALUE FOR OUTPUT LOW

O.HI
 xxxx --> DISPLAY VALUE FOR OUTPUT HIGH

O.ERR
 23 mA --> NAMUR NE43 UPSCALE AT ERROR
 3,5 mA --> NAMUR NE43 DOWNSCALE AT ERROR
 0mA --> DOWNSCALE AT ERROR
 NONE --> UNDEFINED OUTPUT AT ERROR

RESP
 xxx.x --> ANALOGUE OUTPUT RESPONSE TIME
 IN SECONDS

E.PAS
 NO --> ENABLE PASSWORD PROTECTION
 YES

N.PAS
 xxxx --> SELECT NEW PASSWORD

ADV MENU:
 LANG --> ENTER LANGUAGE SETUP
 DISP --> ENTER DISPLAY SETUP
 CAL --> PERFORM PROCESS CALIBRATION

HLP.T
 DE --> DE - WAEHLE DEUTSCHEN HILFETEXT
 DK --> DK - VAELG DANSK HJAELPETEKST
 ES --> ES - SELECCIONAR TEXTO DE
 AYUDA EN ESPANOL
 FR --> FR - SELECTION TEXTE D'AIDE
 EN FRANCAIS
 IT --> IT - SELEZIONARE TESTI DI
 AIUTO ITALIANI
 SE --> SE - VALJ SVENSK HJALPTEXT
 UK --> UK - SELECT ENGLISH HELPTTEXT
 CZ --> CZ - VYBER CESKOU NAPOVEDU

LIGH
 xxxx --> ADJUST DISPLAY LIGHT INTENSITY

CA.LO
 YES --> CALIBRATE INPUT LOW TO PROCESS
 VALUE?
 NO

CA.HI
 YES --> CALIBRATE INPUT HIGH TO PROCESS
 VALUE?
 NO

VAL.L
 xxxx --> SET VALUE FOR LOW CALIBRATION
 POINT

VAL.H
 xxxx --> SET VALUE FOR HIGH CALIBRATION
 POINT

USE.C
 YES --> USE PROCESS CALIBRATED VALUES?
 NO

Configuration / operating the function keys

Documentation for routing diagram.

In general

When configuring the display you are guided through all parameters, you can choose the settings which fit the application. For each menu there is a scrolling help text which is automatically shown in the display, this starts after 5 seconds if no key has been activated.

Configuration is carried out by using the 3 function keys.

- ⏪ will increase the numerical value or choose the next parameter.
- ⏩ will decrease the numerical value or choose the previous parameter.
- ⏹ will accept the chosen value and end the menu.

If a function does not exist in the display all parameters are skipped to make the configuration as simple as possible. Once the configuration has been entered the display will show "----".

Pressing and holding ⏹ will return to the previous menu or return to the default state (1.0) without saving the changed values or parameters.

If no key is activated for 2 minutes, the display will return to the default state (1.0) without saving the changed values or parameters.

Further explanations

Fast setpoint adjustment and relay test: These menus allow you to change the set point quickly and to check the operation of the relays.

Pressing ⏪ and ⏩ at the same time will change the state of the relay - this change is indicated by the diodes on the display. Pressing ⏹ will save the set point change.

Holding down ⏹ for more than 0.5 seconds will return the unit to the default state without changing the set point.

Password protection: Using a password will stop access to the menu and parameters. There are two levels of password protection. Passwords between 0000...4999 allow access to the fast set point adjustment and relay test. (Using this password stops access to all other parts of the menu). Passwords between 5000...9999 stop access to all parts of the menu, fast set point and relay test. (Current set point is still shown). If the configured password is not known, please contact PR electronics support - www.prelectronics.com/contact.

Graphic depiction of the relay function setpoint

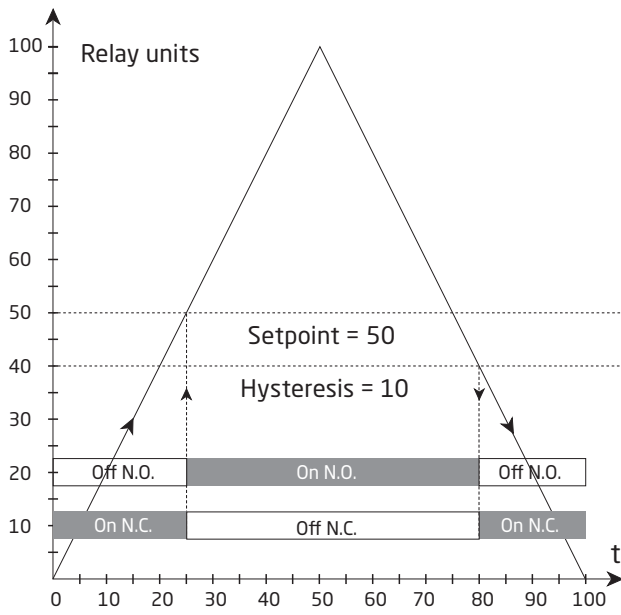

Relay action: Increasing

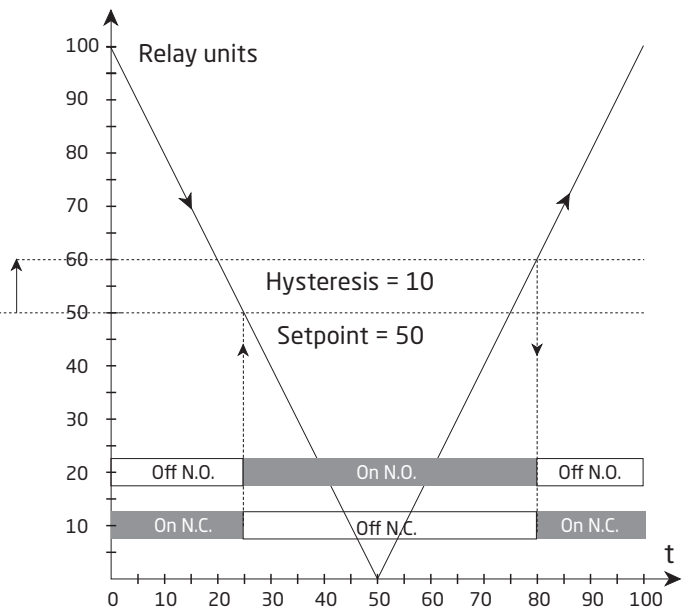

Relay action: Decreasing

Installation instructions

UL installation requirements

For use on a flat surface of a type 1 enclosure

Use 60/75°C copper conductors only

Enclosure rating (face only) acc. to UL50E.	Type 4X
Max. ambient temperature	60°C
Max. wire size, pins 41...46.	AWG 30-16
Max. wire size, others	AWG 30-12
UL file number	E248256

Relay outputs:

Max. voltage	250 VRMS
Max. current.	2 A / AC
Max. AC power	500 VA
Max. current at 24 VDC	1 A

Document history

The following list provides notes concerning revisions of this document.

Rev. ID	Date	Notes
104	1933	Relay data updated, graph with resistive loads inserted.
105	2208	EU-RO marine approval added. UKCA approval added.

We are near you, *all over the world*

Our trusted red boxes are supported wherever you are

All our devices are backed by expert service and a 5-year warranty. With each product you purchase, you receive personal technical support and guidance, day-to-day delivery, repair without charge within the warranty period and easily accessible documentation.

We are headquartered in Denmark, and have offices and authorized partners the world over. We are a local

business with a global reach. This means that we are always nearby and know your local markets well. We are committed to your satisfaction and provide PERFORMANCE MADE SMARTER all around the world.

For more information on our warranty program, or to meet with a sales representative in your region, visit prelectronics.com.

Benefit today from *PERFORMANCE MADE SMARTER*

PR electronics is the leading technology company specialized in making industrial process control safer, more reliable and more efficient. Since 1974, we have been dedicated to perfecting our core competence of innovating high precision technology with low power consumption. This dedication continues to set new standards for products communicating, monitoring and connecting our customers' process measurement points to their process control systems.

Our innovative, patented technologies are derived from our extensive R&D facilities and from having a great understanding of our customers' needs and processes. We are guided by principles of simplicity, focus, courage and excellence, enabling some of the world's greatest companies to achieve PERFORMANCE MADE SMARTER.